



# Model 350DA

## Double Check Detector Assembly

### Application

Designed for installation on water lines in fire protection systems to protect against both backsiphonage and backpressure of polluted water into the potable water supply. Model 350DA shall provide protection where a potential health hazard does not exist. Incorporates metered by-pass to detect leaks and unauthorized water use.

### Standards Compliance

(Sizes 2 1/2" - 10" Horiz. & Vert.)  
(12" Horizontal Only)

- ASSE® Listed 1048 (Sizes 2 1/2" thru 12")
- CSA® Certified B64.5 (Sizes 2 1/2" thru 8", & 12")
- AWWA Compliant C510 (Sizes 2 1/2" thru 12"), and C550
- UL® Classified (Sizes 2 1/2" thru 12")
- C-UL® Classified (Sizes 2 1/2" thru 12")
- FM® Approved (Sizes 2 1/2" thru 10")
- NYC MEA 147-99-M Vol 4 (2-1/2" - 10)
- Approved by the Foundation for Cross Connection Control and Hydraulic Research at the University of Southern California (Sizes 2 1/2" thru 12")
- Meets the requirements of NSF/ANSI/CAN 61\*  
\*(0.25% MAX. WEIGHTED AVERAGE LEAD CONTENT)

### By-Pass Backflow Assembly 3/4" Model 950XLD

### Materials

Main valve body	Ductile Iron ASTM A 536
Access covers	Ductile Iron ASTM A 536
Coatings	NSF Approved fusion epoxy finish
Internals	Stainless steel, 300 Series NORYL™
Fasteners	Stainless Steel, 300 Series
Elastomers	EPDM (FDA approved) Buna Nitrile (FDA approved)
Polymers	NORYL™
Springs	Stainless Steel, 300 Series

### Dimensions & Weights (do not include pkg.)

MODEL 350ADA SIZE	WEIGHT									
	LESS SHUT-OFF VALVES		OS&Y GATE VALVES FLANGED		OS&Y GATE VALVES GROOVED		BUTTERFLY VALVES GROOVED			
	in.	mm	lbs.	kg	lbs.	kg	lbs.	kg	lbs.	kg
2 1/2	65	68	31	178	81	160	73	140	64	
3	80	68	31	198	90	150	68	120	54	
4	100	106	48	296	134	282	128	190	86	
6	150	180	82	480	218	454	206	298	135	
8	200	374	170	850	386	802	364	548	249	
10	250	404	183	1222	554	1156	524	792	359	
12	300	463	210	1623	736	n/a	n/a	n/a	n/a	

**Attention:**  
Model 350DA (flange body) and Model 350ADA (grooved body) have different lay lengths.

MODEL 350DA SIZE	DIMENSION (approximate)																				
	A		A WITH BUTTERFLY VALVES		B LESS GATE VALVES		C		D		E OS&Y OPEN		E OS&Y CLOSED		E WITH BUTTERFLY VALVES		F		G		
	in.	mm	in.	mm	in.	mm	in.	mm	in.	mm	in.	mm	in.	mm	in.	mm	in.	mm	in.	mm	
2 1/2	65	31	787	28	711	15 7/8	403	3 3/4	95	9	229	17 3/4	451	15 3/8	391	13 3/4	349	3 1/2	89	7 1/4	184
3	80	32	813	28 1/2	724	15 7/8	403	3 3/4	95	9	229	20 1/4	514	17	432	13 3/4	349	3 1/2	89	7 1/4	184
4	100	37 5/8	956	32 8/9	835	19 1/2	495	4 1/2	114	9	229	22 1/2	572	18 1/4	464	17	432	6	152	8	203
6	150	44 5/8	1133	37 5/8	956	23 1/2	597	6	152	10 1/2	267	30 1/2	775	24 1/4	616	17 1/2	445	7	178	10	254
8	200	60 7/8	1546	53 7/8	1369	37 3/4	959	10	254	12	305	37	940	28 1/2	724	16 15/16	430	8 1/2	216	11	279
10	250	63 7/8	1622	57 7/8	1470	37 3/4	959	10	254	12	305	45 5/8	1159	34 3/4	883	16 15/16	430	8 1/2	216	12	305
12	300	66 3/16	1681	n/a	n/a	38	965	10	254	12	305	53	1346	40 1/2	1029	n/a	n/a	8 7/8	226	16 3/4	425

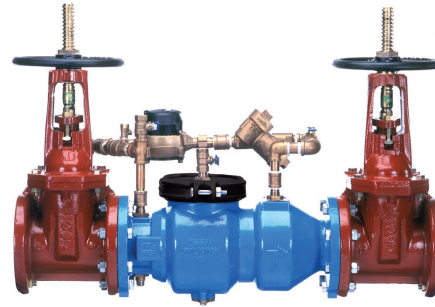

### Options

(Suffixes can be combined)

- with OS & Y gate valves (standard)
- L - less shut-off valves (flanged body connections)
- LM - less water meter
- with gallon meter (standard)
- CFM - with cu ft meter
- CMM - with cu meter meter
- G - with groove end gate valves
- FG - with flanged inlet connection and grooved outlet connection
- PI - with Post Indicator Gate Valve
- GF - with flanged inlet connection and grooved outlet connection
- BG - with grooved end butterfly valves with integral monitor switches (2 1/2" - 10")

### Accessories

- Repair kit (rubber only)
- Thermal expansion tank (Model XT)
- OS & Y Gate valve tamper switch (OSY-40)

### Features

- Sizes: 2 1/2", 3", 4", 6", 8", 10", 12"
- Maximum working water pressure: 175 PSI
- Maximum working water temperature: 140°F
- Hydrostatic test pressure: 350 PSI
- End connections (Grooved for steel): AWWA C606
- (Flanged bolt pattern): ASME B16.42 Class 150

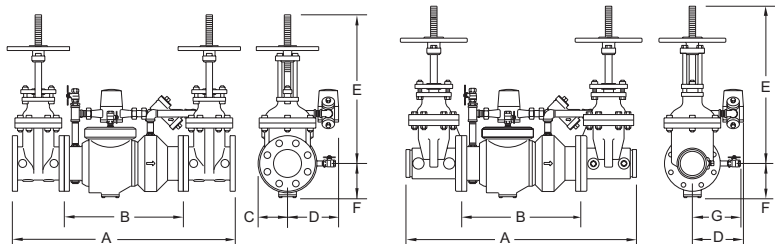

MODEL 350DAG SHOWN ABOVE

**MODEL 350DA 2 1/2", 3" & 4" (STANDARD & METRIC)**

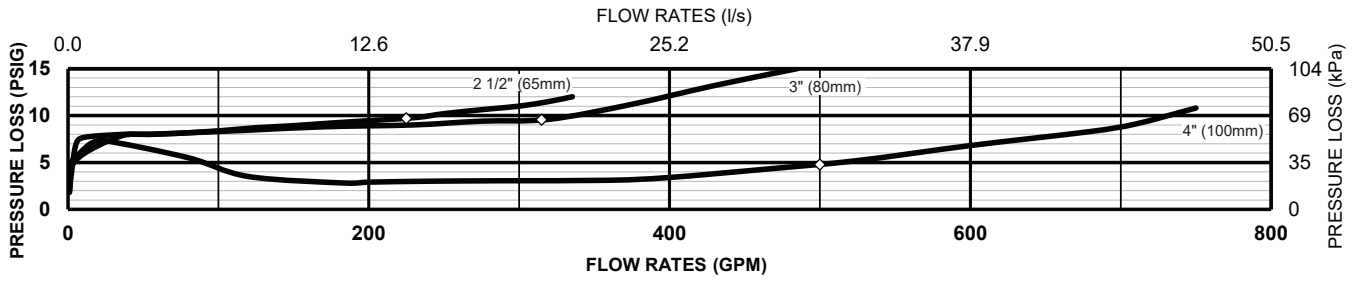

**MODEL 350DA 6" & 8" (STANDARD & METRIC)**

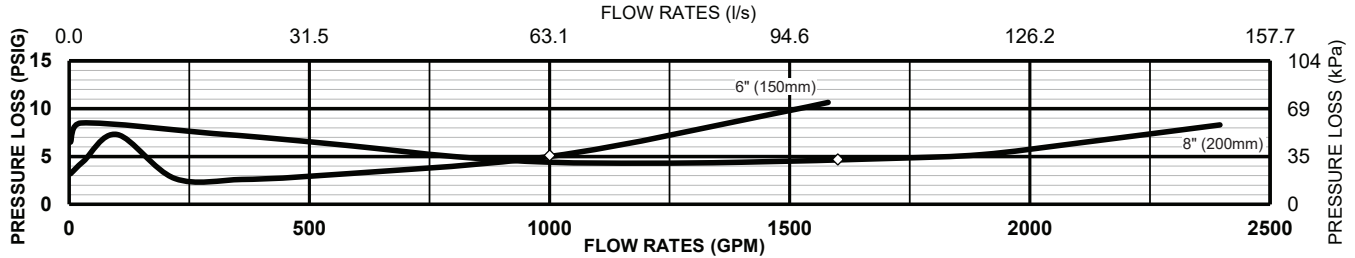

**MODEL 350DA 10" & 12" (STANDARD & METRIC)**

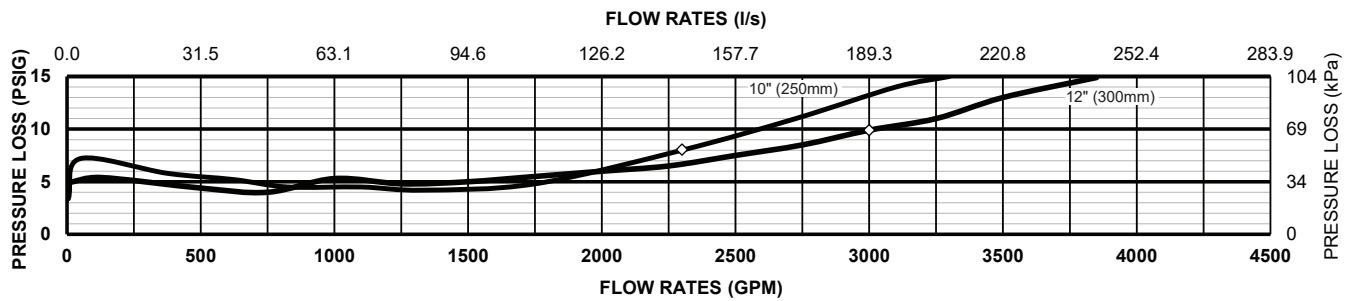

**Typical Installation**

Local codes shall govern installation requirements. Unless otherwise specified, the assembly shall be mounted at a minimum of 12" (305mm) and a maximum of 30" (762mm) above adequate drains with sufficient side clearance for testing and maintenance. The installation shall be made so that no part of the unit can be submerged.

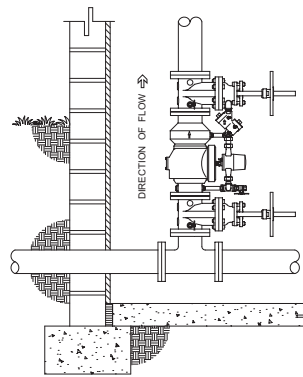

VERTICAL INSTALLATION

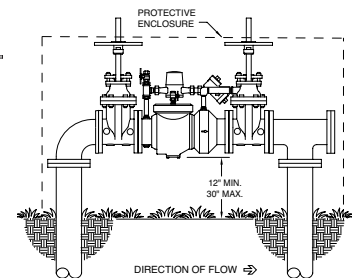

OUTDOOR INSTALLATION

Capacity thru Schedule 40 Pipe (GPM)				
Pipe size	5 ft/sec	7.5 ft/sec	10 ft/sec	15 ft/sec
2 1/2"	75	112	149	224
3"	115	173	230	346
4"	198	298	397	595
6"	450	675	900	1351
8"	780	1169	1559	2339
10"	1229	1843	2458	3687
12"	1763	2644	3525	5288

**Specifications**

The Double Check Detector Backflow Prevention Assembly shall be certified to NSF/ANSI/CAN 61, ASSE® Listed 1048, and supplied with full port gate valves. The main body and access cover shall be epoxy coated ductile iron (ASTM A 536), the seat ring and check valve shall be Noryl™, the stem shall be stainless steel (ASTM A 276) and the seat disc elastomers shall be EPDM. The first and second check valves shall be accessible for maintenance without removing the device from the line. The Double Check Detector Backflow Prevention Assembly shall be a ZURN WILKINS Model 350DA.